



# GAIA 75 Family



GAIA R75



GA75-R01QS

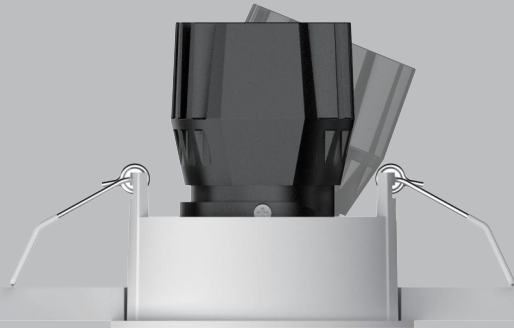

GA75-R01QT

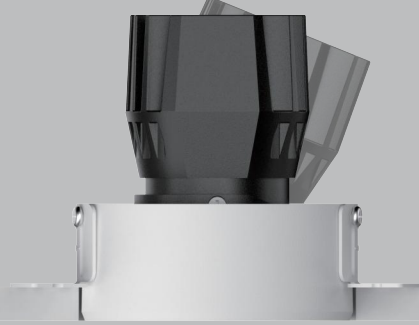

With Trim

Trimless

White

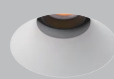

Black

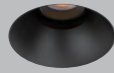
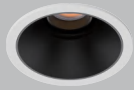

Golden

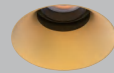
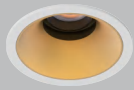

GA75-R01QS



GA75-R01QT

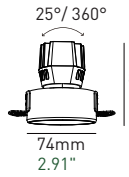

GAIA Family

**Basic Information**

Model	GA75-R01QS/R01QT
Embedded Parts	With Trim/Trimless
Mounting	Recessed
Trim Finishing Color	White/Black
Reflector Color	White/Black/Golden
Material	Aluminum
Cutout Size	∅ 75mm
Light Direction	↓ 25° ↔ 360°
IP Rating	IP20
Power	Max. 12W
Input Voltage	DC36V
Input Current	Max. 300mA

**Optical Parameters**

Light Source	LED COB
Lumens	65lm/W 90lm/W
CRI	97Ra / 90Ra
CCT	3000K ● 3500K ● 4000K ●
CCT Changeable	2700K — 6000K 1800K — 3000K
Beam Angle	▮ 15° ▮ 25° ▮ 35° ▮ 50°
Shielding Angle	46°
UGR	< 13
LED Lifespan	50000hrs

Driver Voltage	AC100-120V AC220-240V
Driver Options	ON/OFF DIM TRIAC/ PHASE-CUT DIM 0/1-10V DIM DALI

# GAIA R75 Snout L



GA75-R03QS

GA75-R03QT

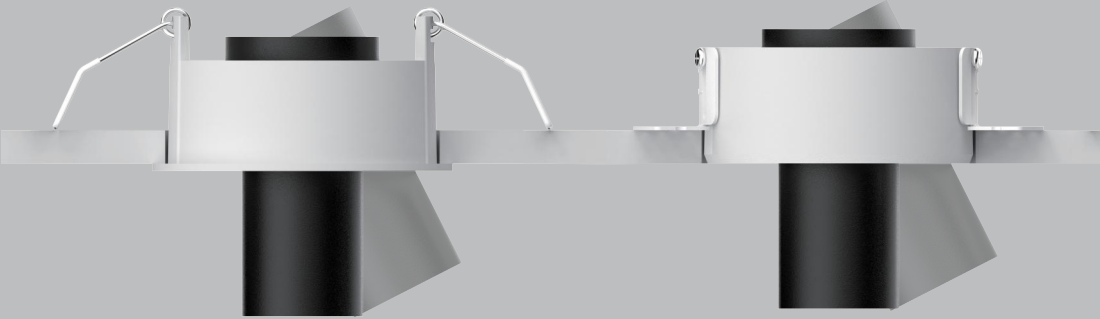

With Trim

Trimless

White



Black



Golden

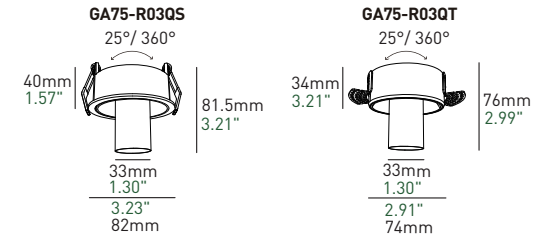
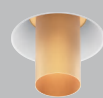

## Basic Information

Model	GA75-R03QS/R03QT
Embedded Parts	With Trim/Trimless
Mounting	Recessed
Trim Finishing Color	White/Black
Reflector Color	White/Black/Golden
Material	Aluminum
Cutout Size	∅ 75mm
Light Direction	↓ 25° ↔ 360°
IP Rating	IP20
Power	Max. 8W
Input Voltage	DC36V
Input Current	Max. 200mA

## Optical Parameters

Light Source	LED COB
Lumens	65lm/W 90lm/W
CRI	97Ra / 90Ra
CCT	3000K ● 3500K ● 4000K ●
CCT Changeable	2700K — 6000K 1800K — 3000K
Beam Angle	▮ 15° ▮ 25° ▮ 35°
Shielding Angle	60°
UGR	< 9
LED Lifespan	50000hrs

Driver Voltage AC100-120V AC220-240V

Driver Options ON/OFF DIM TRIAC/ PHASE-CUT DIM 0/1-10V DIM DALI

# GAIA R75 Snout



GA75-R05QS

GA75-R05QT



With Trim

Trimless

White

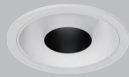

Black

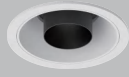

Golden

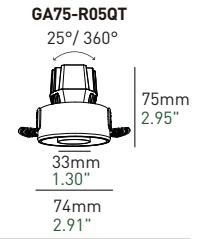
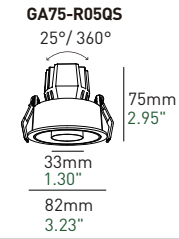
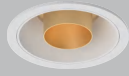

## Basic Information

Model	GA75-R05QS/R05QT
Embedded Parts	With Trim/Trimless
Mounting	Recessed
Trim Finishing Color	White/Black
Reflector Color	White/Black/Golden
Material	Aluminum
Cutout Size	75mm
Light Direction	25° 360°
IP Rating	IP20
Power	Max. 12W
Input Voltage	DC36V
Input Current	Max. 300mA

## Optical Parameters

Light Source	LED COB
Lumens	65lm/W 90lm/W
CRI	97Ra / 90Ra
CCT	3000K 3500K 4000K
CCT Changeable	2700K 6000K 1800K 3000K
Beam Angle	15° 25° 35°
Shielding Angle	60°
UGR	<9
LED Lifespan	50000hrs

Driver Voltage AC100-120V AC220-240V

Driver Options ON/OFF DIM TRIAC/ PHASE-CUT DIM 0/1-10V DIM DALI



GA75-R44QS

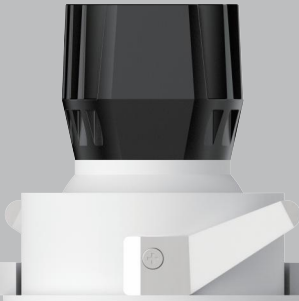

With Trim

White



Black

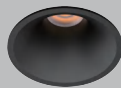

GA75-R44QS



82mm  
3.23"

82mm  
3.23"

**Basic Information**

Model	GA75-R44QS
Embedded Parts	With Trim
Mounting	Recessed
Trim Finishing Color	White/Black
Reflector Color	White/Black/Golden
Material	Aluminum
Cutout Size	75mm
IP Rating	IP44
Power	Max. 12W
Input Voltage	DC36V
Input Current	Max. 300mA

**Optical Parameters**

Light Source	LED COB
Lumens	65lm/W 90lm/W
CRI	97Ra / 90Ra
CCT	3000K ● 3500K ● 4000K ○
CCT Changeable	2700K — 6000K 1800K — 3000K
Beam Angle	15° 25° 35° 50°
Shielding Angle	46°
UGR	<13
LED Lifespan	50000hrs

Driver Voltage	AC100-120V AC220-240V
Driver Options	ON/OFF DIM TRIAC/ PHASE-CUT DIM 0/1-10V DIM DALI

# GAIA R75 Pinhole



GA75-R06QS

GA75-R06QT



With Trim

Trimless

White



Black



GA75-R06QS

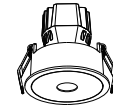

20mm  
0.787"  
82mm  
3.23"

83mm  
3.27"

GA75-R06QT

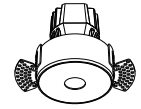

20mm  
0.787"  
74mm  
2.91"

83mm  
3.27"

GAIA Family

## Basic Information

Model	GA75-R06QS/R06QT
Embedded Parts	With Trim/Trimless
Mounting	Recessed
Trim Finishing Color	White/Black
Reflector Color	White/Black
Material	Aluminum
Cutout Size	∅ 75mm
IP Rating	IP20
Power	Max. 12W
Input Voltage	DC36V
Input Current	Max. 300mA

## Optical Parameters

Light Source	LED COB
Lumens	30lm/W
CRI	97Ra
CCT	3000K ● 3500K ● 4000K ●
CCT Changeable	2700K  6000K 1800K  3000K
Beam Angle	25°
LED Lifespan	50000hrs

Driver Voltage	AC100-120V AC220-240V
Driver Options	ON/OFF DIM TRIAC/ PHASE-CUT DIM 0/1-10V DIM DALI



GA75-R01QS (with plate M-GA01-K01)



White

Black

White



Black



GA75-R01QS (with plate M-GA01-K01)

M-GA01-K01



GA75-R01QS



25° / 360°

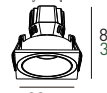

83mm  
3.27"  
82mm  
3.23"  
86mm  
3.39"

### Basic Information

Model	GA75-R01QS (with plate M-GA01-K01)
Embedded Parts	With Trim
Mounting	Recessed
Trim Finishing Color	White/Black
Reflector Color	White/Black/Golden
Material	Aluminum
Cutout Size	∅ 75mm
Light Direction	↓ 25° ↔ 360°
IP Rating	IP20
Power	Max.12W
Input Voltage	DC36V
Input Current	Max. 300mA

### Optical Parameters

Light Source	LED COB
Lumens	65lm/W 90lm/W
CRI	97Ra / 90Ra
CCT	3000K ● 3500K ● 4000K ●
CCT Changeable	2700K — 6000K 1800K — 3000K
Beam Angle	▮ 15° ▮ 25° ▮ 35° ▮ 50°
Shielding Angle	46°
UGR	<13
LED Lifespan	50000hrs

Driver Voltage	AC100-120V AC220-240V
Driver Options	ON/OFF DIM TRIAC/ PHASE-CUT DIM 0/1-10V DIM DALI



Double GA75-R01QS (with plate M-GA01-K02)

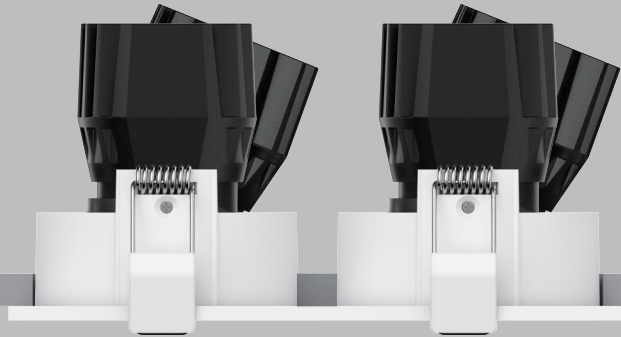

White

Black

White



Black



M-GA01-K02



Double GA75-R01QS

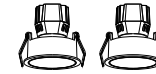

Double GA75-R01QS (with plate M-GA01-K02)

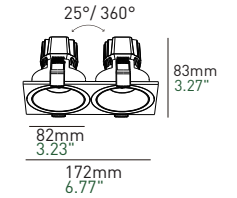

### Basic Information

Model	Double GA75-R01QS (with plate M-GA01-K02)
Embedded Parts	With Trim
Mounting	Recessed
Trim Finishing Color	White/Black
Reflector Color	White/Black/Golden
Material	Aluminum
Cutout Size	160*75mm
Light Direction	25° 360°
IP Rating	IP20
Power	Max. 2*12W
Input Voltage	DC36V
Input Current	Max. 2*300mA

### Optical Parameters

Light Source	LED COB
Lumens	65lm/W 90lm/W
CRI	97Ra / 90Ra
CCT	3000K 3500K 4000K
CCT Changeable	2700K 6000K 1800K 3000K
Beam Angle	15° 25° 35° 50°
Shielding Angle	46°
UGR	<13
LED Lifespan	50000hrs

Driver Voltage AC100-120V AC220-240V

Driver Options ON/OFF DIM TRIAC/ PHASE-CUT DIM 0/1-10V DIM DALI



# GAIA S75 Single



GA75-S01QS

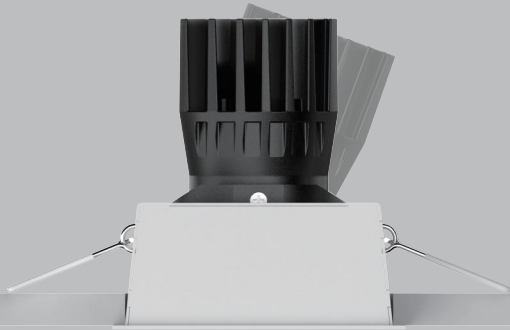

GA75-S01QT

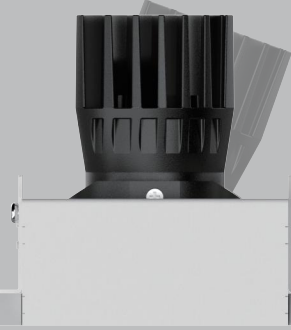

With Trim

Trimless

White



Black



Golden



GA75-S01QS

25° / 360°



82mm  
3.23"

GA75-S01QT

25° / 360°

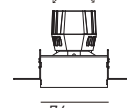

74mm  
2.91"

87mm  
3.43"

87mm  
3.43"

## Basic Information

Model	GA75-S01QS/S01QT
Embedded Parts	With Trim/Trimless
Mounting	Recessed
Trim Finishing Color	White/Black
Reflector Color	White/Black/Golden
Material	Aluminum
Cutout Size	75*75mm
Light Direction	25° 360°
IP Rating	IP20
Power	Max. 12W
Input Voltage	DC36V
Input Current	Max. 300mA

## Optical Parameters

Light Source	LED COB
Lumens	65lm/W 90lm/W
CRI	97Ra / 90Ra
CCT	3000K 3500K 4000K
CCT Changeable	2700K 6000K 1800K 3000K
Beam Angle	15° 25° 35° 50°
Shielding Angle	46°
UGR	<13
LED Lifespan	50000hrs

Driver Voltage	AC100-120V AC220-240V
Driver Options	ON/OFF DIM TRIAC/ PHASE-CUT DIM 0/1-10V DIM DALI

# GAIA S75 Double



GA75-S01QS2

GA75-S01QT2

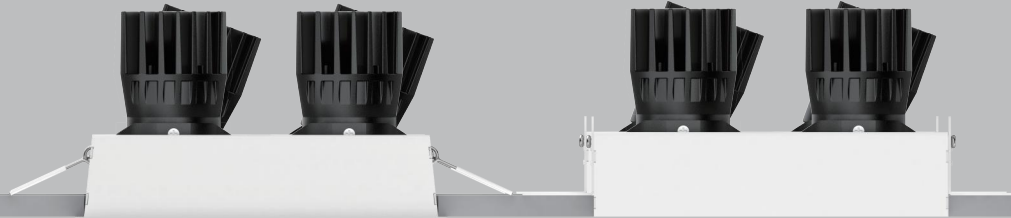

With Trim

Trimless

White



Black



Golden

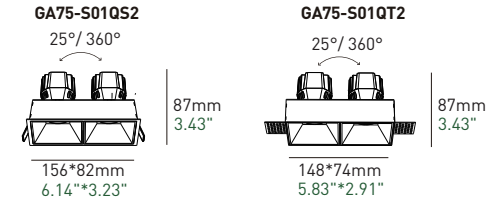

## Basic Information

Model	GA75-S01QS2/S01QT2
Embedded Parts	With Trim/Trimless
Mounting	Recessed
Trim Finishing Color	White/Black
Reflector Color	White/Black/Golden
Material	Aluminum
Cutout Size	150*75mm
Light Direction	25° 360°
IP Rating	IP20
Power	Max. 2*12W
Input Voltage	DC36V
Input Current	Max. 2*300mA

## Optical Parameters

Light Source	LED COB
Lumens	65lm/W 90lm/W
CRI	97Ra / 90Ra
CCT	3000K 3500K 4000K
CCT Changeable	2700K 6000K 1800K 3000K
Beam Angle	15° 25° 35° 50°
Shielding Angle	46°
UGR	<13
LED Lifespan	50000hrs

Driver Voltage	AC100-120V AC220-240V
Driver Options	ON/OFF DIM TRIAC/ PHASE-CUT DIM 0/1-10V DIM DALI

# GAIA 55 Family



GAIA R55



GA55-R01QS

GA55-R01QT



With Trim

Trimless

White

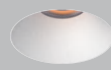
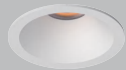

Black

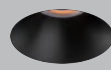
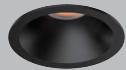

GA55-R01QS



GA55-R01QT



**Basic Information**

Model	GA55-R01QS/R01QT
Embedded Parts	With Trim/Trimless
Mounting	Recessed
Trim Finishing Color	White/Black
Reflector Color	White/Black
Material	Aluminum
Cutout Size	∅ 55mm
IP Rating	IP20
Power	Max. 10W
Input Voltage	DC36V
Input Current	Max. 250mA

**Optical Parameters**

Light Source	LED COB
Lumens	65lm/W 90lm/W
CRI	97Ra / 90Ra
CCT	3000K ● 3500K ● 4000K ○
CCT Changeable	2700K — 6000K 1800K — 3000K
Beam Angle	▲ 15° ▲ 25° ▲ 35° ▲ 50°
Shielding Angle	38°
UGR	< 16
LED Lifespan	50000hrs

Driver Voltage	AC100-120V AC220-240V
Driver Options	ON/OFF DIM TRIAC/ PHASE-CUT DIM 0/1-10V DIM DALI

GAIA Family

# GAIA R55 Semi-recessed



GA55-R11QS

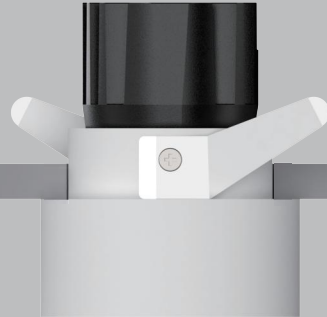

White



Black



Golden



GA55-R11QS

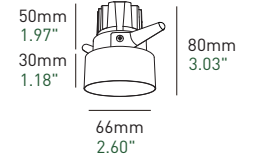

## Basic Information

Model	GA55-R11QS
Mounting	Semi-recessed
Trim Finishing Color	White/Black
Reflector Color	White/Black/Golden
Material	Aluminum
Cutout Size	∅ 55mm
IP Rating	IP20
Power	Max. 10W
Input Voltage	DC36V
Input Current	Max. 250mA

## Optical Parameters

Light Source	LED COB
Lumens	65lm/W 90lm/W
CRI	97Ra / 90Ra
CCT	3000K ● 3500K ● 4000K ○
CCT Changeable	2700K — 6000K 1800K — 3000K
Beam Angle	15° 25° 35° 50°
Shielding Angle	42°
UGR	< 13
LED Lifespan	50000hrs

Driver Voltage	AC100-120V AC220-240V
Driver Options	ON/OFF DIM TRIAC/ PHASE-CUT DIM 0/1-10V DIM DALI

# GAIA R55 Trumpet



GA55-R21QS

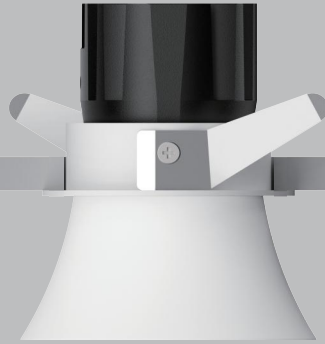

White



Black



Golden



GA55-R21QS

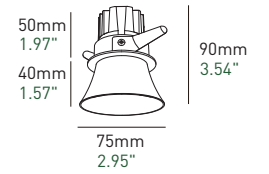

GAIA Family

## Basic Information

Model	GA55-R21QS
Mounting	Semi-recessed
Trim Finishing Color	White/Black
Reflector Color	White/Black/Golden
Material	Aluminum
Cutout Size	∅ 55mm
IP Rating	IP20
Power	Max. 10W
Input Voltage	DC36V
Input Current	Max. 250mA

## Optical Parameters

Light Source	LED COB
Lumens	65lm/W 90lm/W
CRI	97Ra / 90Ra
CCT	3000K ● 3500K ● 4000K ○
CCT Changeable	2700K — 6000K 1800K — 3000K
Beam Angle	15° 25° 35° 50°
Shielding Angle	55°
UGR	<9
LED Lifespan	50000hrs

Driver Voltage	AC100-120V AC220-240V
Driver Options	ON/OFF DIM TRIAC/ PHASE-CUT DIM 0/1-10V DIM DALI