

GEEK Square IP44

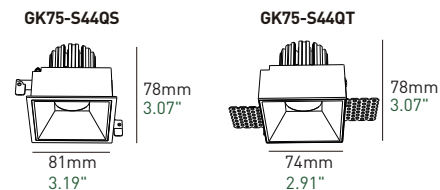

GK75-S44QS

GK75-S44QT

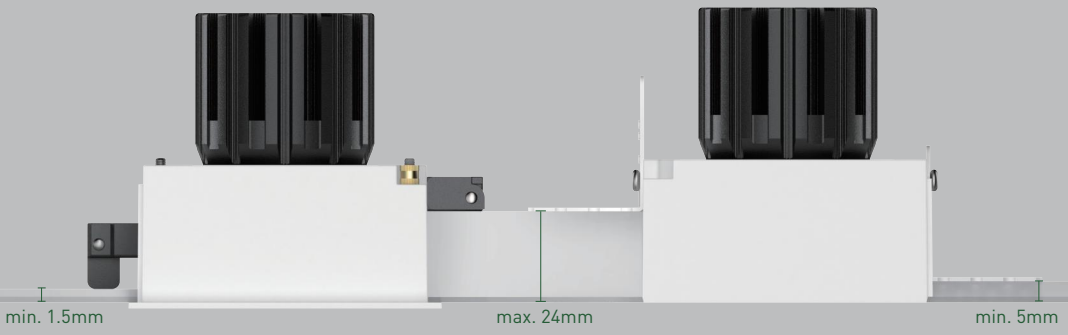

With Trim

Trimless

White



Black



Golden

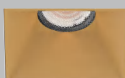

Basic Information

Model	GK75-S44QS/S44QT
Embedded Parts	With Trim/Trimless
Mounting	Recessed
Trim Finishing Color	White/Black
Reflector Color	White/Black/Golden
Material	Cold Forged Pure Alu. (Heat Sink)/Die-casting Alu.
Cutout Size	75*75mm
Light Direction	Fixed
IP Rating	IP44
Power	Max. 15W
Input Voltage	DC36V
Input Current	Max. 350mA

Optical Parameters

Light Source	LED COB
Lumens	65lm/W 90lm/W
CRI	97Ra / 90Ra
CCT	3000K ● 3500K ● 4000K ●
CCT Changeable	2700K — 6000K 1800K — 3000K
Beam Angle	15° 25° 35° 50°
Shielding Angle	35°
UGR	<16
LED Lifespan	50000hrs

Driver Voltage	AC100-120V AC220-240V
Driver Options	ON/OFF DIM TRIAC/ PHASE-CUT DIM 0/1-10V DIM DALI

GEEK Square IP44 Double/Four Heads



Geek Family

GK75-S44QS2

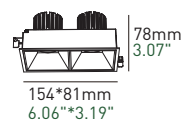

GK75-S44QT2

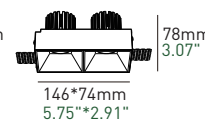

GK75-S44QS4

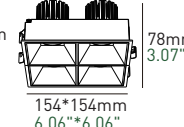

GK75-S44QT4

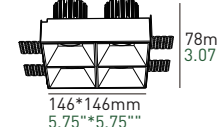

GK75-S44QS2/4

GK75-S44QT2/4

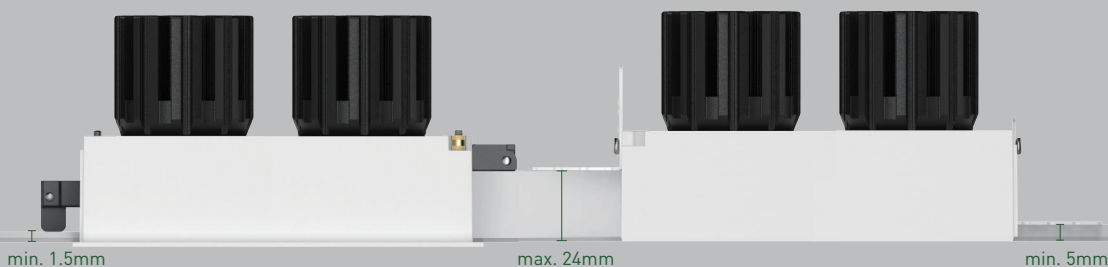

With Trim

Trimless

White



Black



Golden



Basic Information

Model	GK75-S44QS2/4 GK75-S44QT2/4
Embedded Parts	With Trim/Trimless
Mounting	Recessed
Trim Finishing Color	White/Black
Reflector Color	White/Black/Golden
Material	Cold Forged Pure Alu. (Heat Sink)/Die-casting Alu.
Cutout Size	□ L148*75mm / L148*148mm
Light Direction	Fixed
IP Rating	IP44
Power	Max. 2*15W/4*15W
Input Voltage	DC36V
Input Current	Max. 2*350mA/4*350mA

Optical Parameters

Light Source	LED COB
Lumens	65lm/W 90lm/W
CRI	97Ra / 90Ra
CCT	3000K ● 3500K ● 4000K ○
CCT Changeable	2700K — 6000K 1800K — 3000K
Beam Angle	▮ 15° ▮ 25° ▮ 35° ▮ 50°
Shielding Angle	35°
UGR	<16
LED Lifespan	50000hrs

Driver Voltage	AC100-120V AC220-240V
Driver Options	ON/OFF DIM TRIAC/ PHASE-CUT DIM 0/1-10V DIM DALI